

Easy Servo Systems

Closed-loop, No Tuning



- High Performance
- High Quality
- Highly Cost-effective

(Holding Torque: 0.9 Nm to 20 Nm)

Leading Technology

Shining Value

01 ES Series Easy Servo Systems

1.1 Introduction

The ES series easy servos offer an alternative for applications requiring high performance and high reliability when the servo was the only choice, while it remains cost-effective. The system includes an easy servo motor combined with a fully digital, high performance easy servo drive. The internal encoder is used to close the position, velocity and current loops in real time, just like servo systems. It combines the best of servo and stepper motor technologies, and delivers unique capabilities and enhancements over both, while at a fraction of the cost of a servo system !

Beside can be used to upgrade all stepper systems, its great feature of quick response and no hunting make it ideal for applications such as bonding and vision systems in which rapid motions with a short distance are required and hunting would be a problem. And it is ideal for applications where the equipment uses a belt-drive mechanism or otherwise has low rigidity and you don't want it to vibrate when stopping.

1.2 Advantages

Compare to a Conventional Stepper

- Closed-loop, eliminates loss of synchronization
- Broader operating range, higher torque and higher speed
- Reduced motor heating and more efficient
- Smooth motion and extra-low motor noise
- Do not need a high torque margin

Compare to a Conventional Servo

- No tuning for most of applications and always stable
- Quick response, no delay and almost no settling time
- No hunting or no inherent dither
- High torque at starting and low speed, high stiffness at standstill
- Lower cost

1.3 Features

Closed-loop, eliminates loss of synchronization

The ES series use an encoder to detect the motor's real position continuously. If necessary, the ES drives will compensate the loss of synchronization, which is usually caused by abrupt load fluctuations or accelerations, and can not be compensated with a conventional stepper. Thus, the ES can provide very reliable control like a servo.

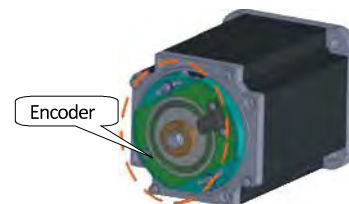

Broader operating range

Owing to closed-loop control and advanced control algorithm, the ES series do not need to size with a 50% torque margin as a conventional stepper system. Instead, the ES series can continuously operate at their maximum capabilities without loss of synchronism, achieving a broader operating range. The same size, but can output higher torque and run at higher speed.

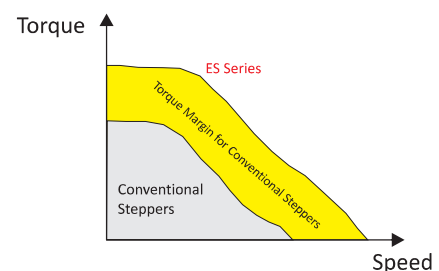

Reduced motor heating and more efficient

Since the motor runs in closed-loop, the ES drives only put as much current into the motor as required to drive the motor to the target. Motor heat is 20 - 40 °C lower compare to using a conventional stepper drive which runs at full current most of the time. Less power consumption and longer motor lifetime can be achieved, reducing using and maintenance cost.

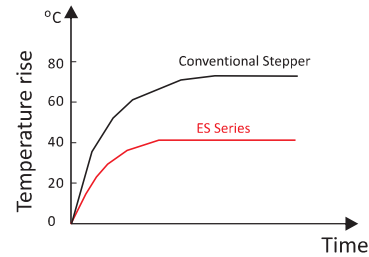

Smooth motion and Extra-low motor noise

Unlike a conventional stepper drive, the ES drives adopt vector control and filtering, producing a smooth motion with minimum torque ripples. Extra-low motor noise is achieved.

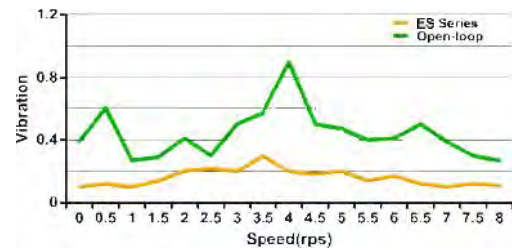

Quick response, no hunting

For the case of traditional servo motor systems, there is a considerable delay between the commanding input signals and the resultant motion because of the constant monitor of the current position, necessitating a waiting time until it settles, called settling time.

Since the ES series is a stepper motor based system, it operates in synchronism with command pulses and has no hunting problem. When it stops, its position is completely stable and does not fluctuate. It is a great feature of the ES when rapid motions with a short distance are required and it is ideal for applications such as bonding and vision systems in which hunting would be a problem.

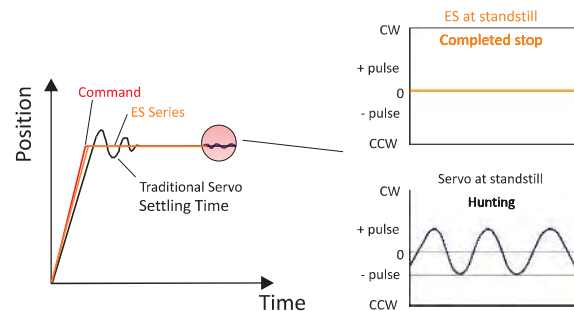

Plug and play, no tuning for most of applications

Unlike a conventional servo system which usually needs the engineer to spend a long time to learn how to use tuning tools and tune the gains for a satisfying performance, the ES series is ready for operation within a very short period of time. Connect the motor to the drive, set the microstep resolution and operating current, then the system is ready and offers high performance approaching to a fine tuned servo. Save time and save cost.



High torque at starting/low speed, high inertial loads

Since the ES series is a stepper motor based system, so it has the advantages of high stiffness at standstill, high torque at starting and low speed, eliminating gear box. The ES adopts sophisticated control algorithms to take advantage of high-torque capability, providing direct-drive of high inertia loads such as flywheels and belt drives. These load inertias may be as large as 100 times the motor inertia while still providing smooth positioning control. Traditional servo systems typically cannot exceed a 10:1 inertial mismatch.

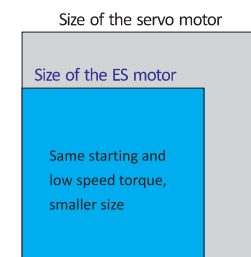

01 ES Series Easy Servo Systems

1.4 Part Number

ES - D 808

① ② ③

- ① **ES:** Easy Servo
- ② **D:** Drive **DH:** High Voltage Drive (AC input)
- ③ **508:** 50VDC, 8A Peak;
808: 80VDC, 8A Peak; **1008:** 100VDC, 8A Peak ...
1208: 120 VAC, 8A Peak; **2306:** 230 VAC, 6A Peak ...

ES - M 2 23 20

① ② ③ ④ ⑤

- ① **ES:** Easy Servo
- ② **M:** Motor
MH: High Voltage Motor
- ③ **Motor Type:**
2: 2-phase;
3: 3-phase
- ④ **Motor Size:**
23: NEMA23 / □ 57 mm
34: NEMA34 / □ 86 mm
- ⑤ **Holding Torque:**
09: 0.9 N*m
20: 2.0 N*m
40: 4.0 N*m ...

Drive	ES-D508		ES-D808		ES-DH2306		
							
	24 to 50 VDC, Typical: 36 VDC		24 to 80 VDC, Typical: 48 VDC		150 to 240 VAC, Typical: 220 VAC		
Motor	NEMA23		NEMA24		NEMA42		
							
	ES-M32309 0.9 Nm	ES-M32320 2 Nm	ES-M22415 1.5 Nm	ES-M22430 3 Nm	ES-MH342120 12 Nm	ES-MH342200 20 Nm	
Drive	ES-D808 / ES-D1008		ES-D1008 / ES-D808		ES-DH1208		ES-DH2306
							
	24 to 80 VDC, Typical: 48 VDC		24 to 100 VDC, Typical: 60 VDC		90 to 130 VAC, Typical: 110 VAC		150 to 240 VAC, Typical: 220 VAC
Motor	NEMA34						
							
	ES-M23440 4 Nm	ES-M23480 8 Nm	ES-MH23480 8 Nm	ES-MH234120 12 Nm	ES-MH33480 8 Nm		

02 ES Series Easy Servo Drives

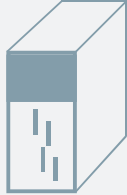

Operating Voltage up to



2.1 Specifications

Model	ES-D508	ES-D808	ES-D1008	ES-DH1208	ES-DH2306
Operating Voltage	18 to 48 VDC	24 to 75 VDC	24 to 70 VAC	90 to 130 VAC	150 to 240 VAC
Output (Peak)	8.0 A			6.0 A	
Control Algorithm	SVPWM				
Maximum Input Frequency	200 kHz*				
Command Input	Step/Direction, Enable/Disable				
Status Output	In position, Fault status				
Encoder Feedback	A, B (differential)				
Protection Functions	Over-current, Over-voltage, Position following error				
Matching Motors	ES-M32309 ES-M32320	ES-M22415 ES-M22430	ES-M23440 ES-M23480	ES-MH234120 ES-MH23480	ES-MH33480 ES-MH342120 ES-MH342200
Encoder Resolution	1000 line				
Weight	280 g	570 g	600 g	1600 g	1800 g

*Can be customized.



2.2 Typical System Configurations

ES-D508/ES-D808/ES-D1008

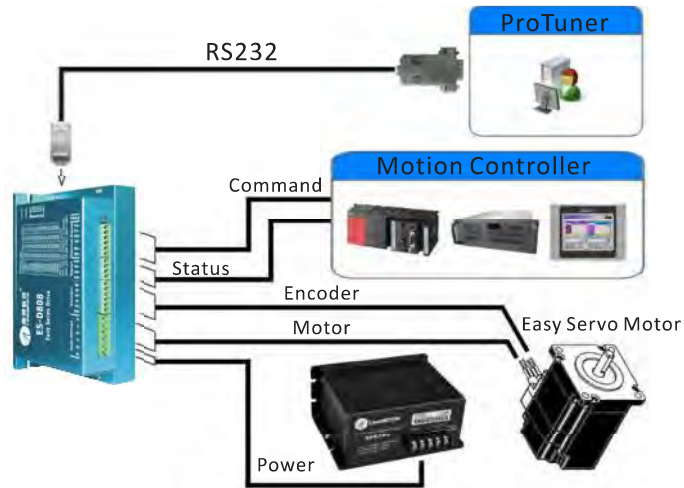

ES-DH1208/ES-DH2306

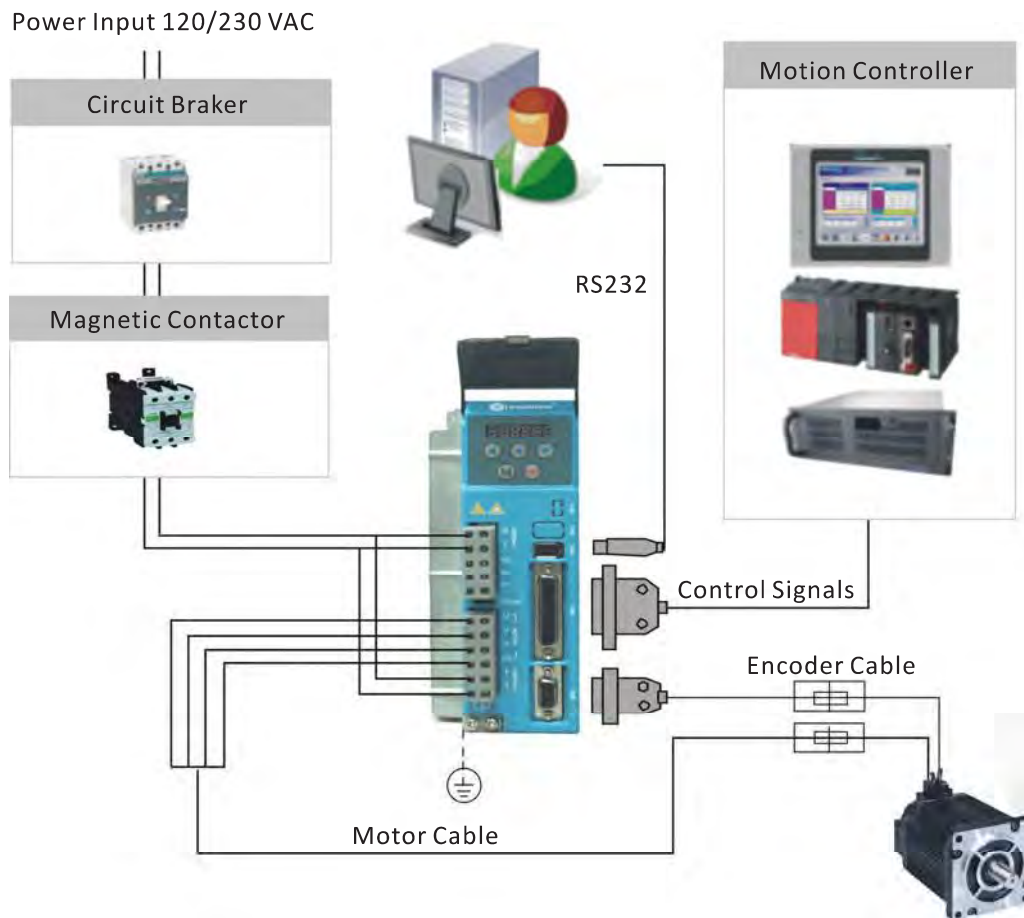

2.3 Mechanical Specifications

Units: mm 1 inch = 25.4mm

ES-D508

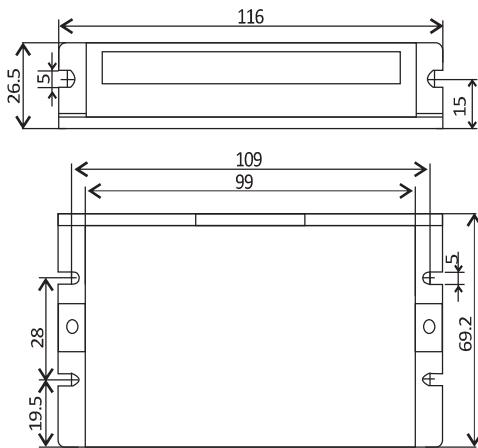

ES-D808 / ES-D1008

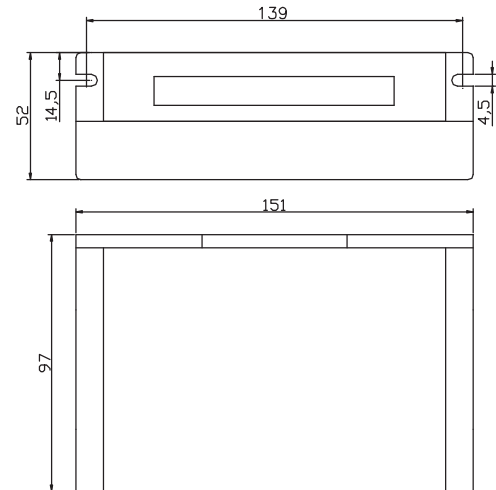

ES-DH1208 / ES-DH2306

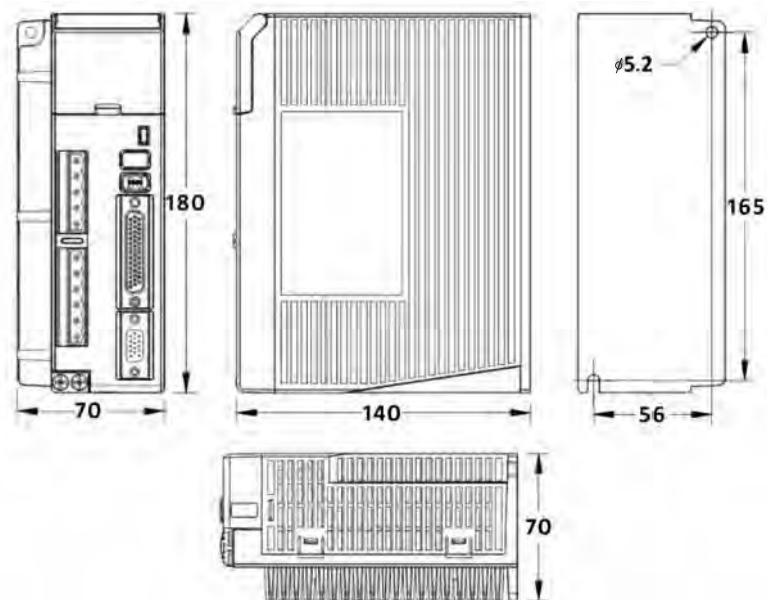

03 ES Series Easy Servo Motors

	Frame Size	NEMA23 (57mm)	NEMA24 (60mm)	NEMA34 (86mm)	NEMA42 (110mm)
	Rated Power	0.9 Nm 2.0 Nm	1.5 Nm 3.0 Nm	4.0 Nm 8.0 Nm 12.0 Nm	12.0 Nm 20.0 Nm

Low and medium voltage



ES-M32309
ES-M32320



ES-M22415
ES-M22430



ES-M23440
ES-M23480

High voltage



ES-MH33480



ES-MH23480
ES-MH234120



ES-MH342120
ES-MH342200

3.1 Specifications

Low and medium voltage

Model	Units	ES-M32309	ES-M32320	ES-M22415	ES-M22430	ES-M23440	ES-M23480
Current/Phase	A	5.8	5.8	2.5	3	5.5	6
Holding Torque	Nm	0.9	2	1.5	3	4	8
Speed Range	RPM	0 to 2000	0 to 2000	0 to 2000	0 to 2000	0 to 2000	0 to 2000
Weight	Kg	0.85	1.4	1.1	1.6	2.56	3.95

High voltage

Model	Units	ES-MH23480	ES-MH234120	ES-MH33480	ES-MH342120	ES-MH342200
Current/Phase	A	5.0	5.5	3.5	4.0	4.5
Holding Torque	Nm	8	12	8	12	20
Speed Range	RPM	0 to 2000	0 to 2000	0 to 2000	0 to 2000	0 to 2000
Weight	Kg	4.0	5.6	5.6	8.6	10.5

3.2 Speed-Torque Curves and Mechanical Specifications

(a) ES-M32309 and ES-M32320

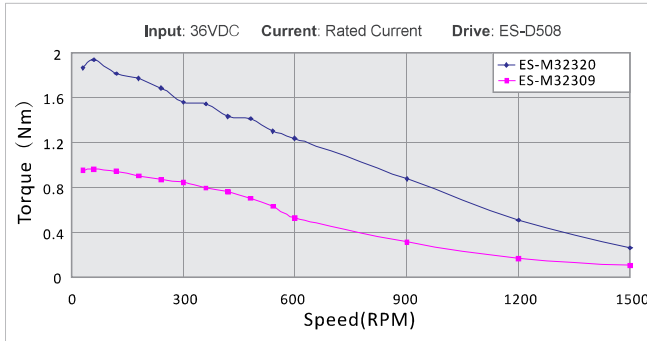

Units: mm 1 inch = 25.4mm

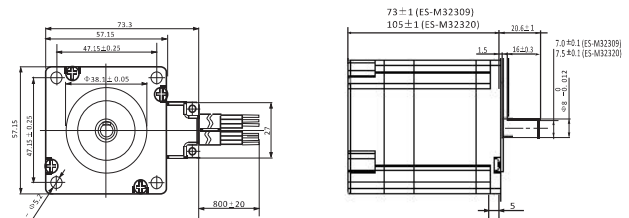

(b) ES-M22415 and ES-M22430

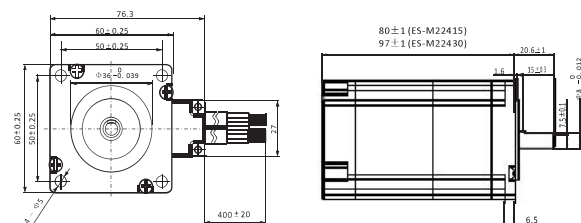
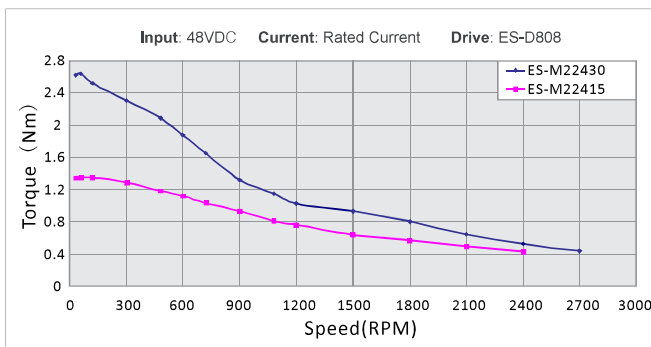

3.2 Speed-Torque Curves and Mechanical Specifications

(c) ES-M23440 and ES-M23480

Units: mm 1 inch = 25.4mm

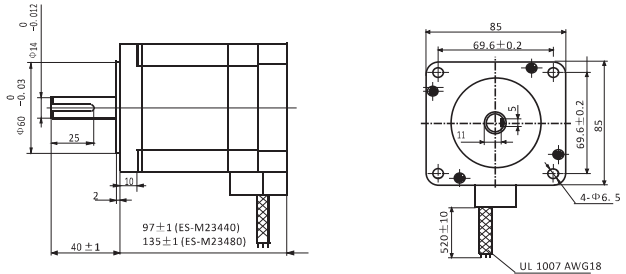
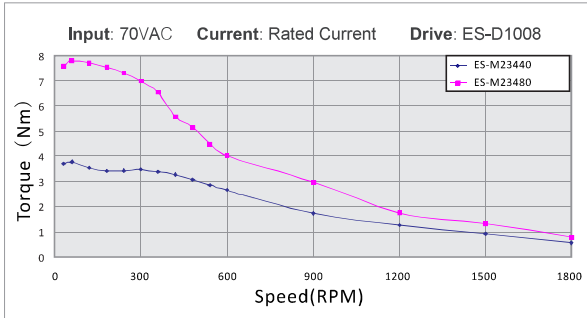

(d) ES-MH23480 and ES-MH234120

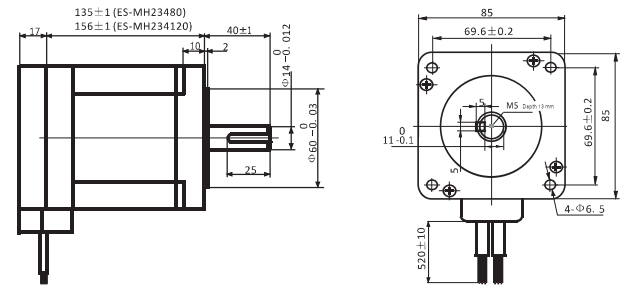
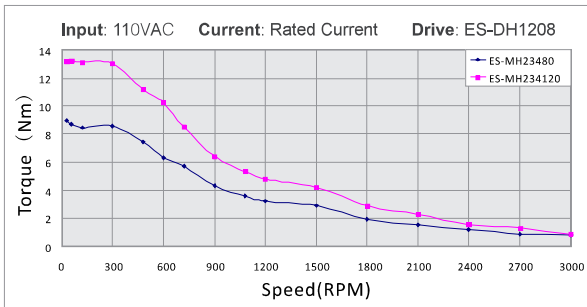

(e) ES-MH33480

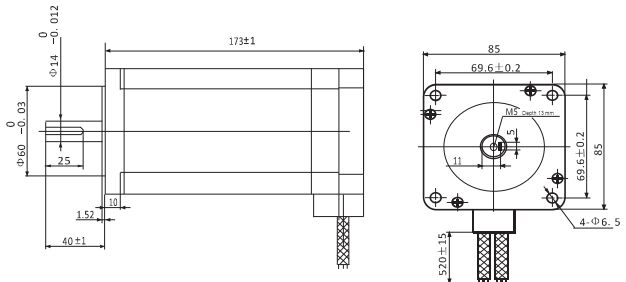
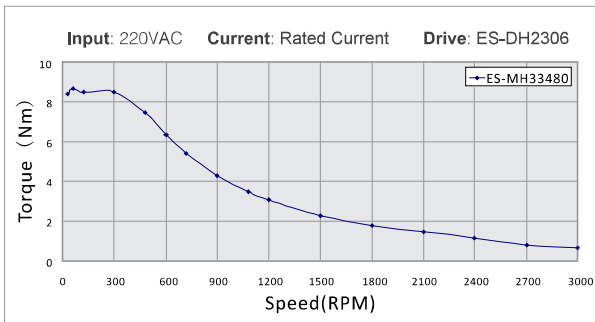

(f) ES-MH342120 and ES-MH342200

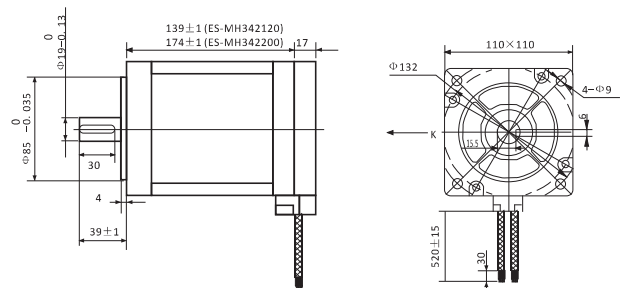
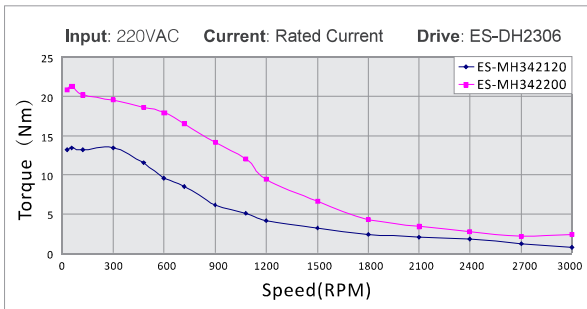

04 ES Series Accessories

Number	Picture	Name	Discreption
1		Motor Cable: CABLEH-RZ3M0 CABLEH-RZ5M0 CABLEH-RZ10M0	Length 3 m (Standard) , 5m and 10m optional For the ES-D508, ES-D808, ES-D1008, ES-DH1208 and ES-DH2306.
2		Encoder Cable: CABLEG-BM3M0 CABLEG-BM5M0 CABLEG-BM10M0	Length 3 m (Standard) , 5m and 10m optional For the ES-D508, ES-DH1208 and ES-DH2306.
3		Encoder Cable: CABLEH-BM3M0 CABLEH-BM5M0 CABLEH-BM10M0	Length 3 m (Standard) , 5m and 10m optional For the ES-D1008 and ES-D808
4		RS232 Cable for ProTuner: CABLE-ACH1000	Length 1.2 m For the ES-DH2308 and ES-DH1208
5		RS232 Cable for ProTuner: CABLE-PC	Length 1.2 m For the ES-D508, ES-D808 and ES-D1008
6		Control Signal Connector: HDB-44P	Control Signal Connector for the ES-DH1208 and ES-DH2306.

05 ES Series Order Information

Easy Servo Packages	Motors	Drives	Accessories
ES-P2309	ES-M32309	ES-D508	CABLEH-RZ3M0,CABLEG-BM3M0, CABLE-PC *
ES-P2320	ES-M32320	ES-D508	CABLEH-RZ3M0,CABLEG-BM3M0, CABLE-PC *
ES-P2415	ES-M22415	ES-D808	CABLEH-RZ3M0,CABLEH-BM3M0, CABLE-PC *
ES-P2430	ES-M22430	ES-D808	CABLEH-RZ3M0,CABLEH-BM3M0, CABLE-PC *
ES-P3440	ES-M23440	ES-D808	CABLEH-RZ3M0,CABLEH-BM3M0, CABLE-PC *
ES-P3480	ES-M23480	ES-D1008	CABLEH-RZ3M0,CABLEH-BM3M0, CABLE-PC *
ES-P3480H-1	ES-MH23480	ES-DH1208	CABLEH-RZ3M0,CABLEG-BM3M0, CABLE-ACH1000, HDB-44P *
ES-P3480H-2	ES-MH33480	ES-DH2306	CABLEH-RZ3M0,CABLEG-BM3M0, CABLE-ACH1000, HDB-44P *
ES-P34120H-1	ES-MH234120	ES-DH1208	CABLEH-RZ3M0,CABLEG-BM3M0, CABLE-ACH1000, HDB-44P *
ES-P42120	ES-MH342120	ES-DH2306	CABLEH-RZ3M0,CABLEG-BM3M0, CABLE-ACH1000, HDB-44P *
ES-P42200	ES-MH342200	ES-DH2306	CABLEH-RZ3M0,CABLEG-BM3M0, CABLE-ACH1000, HDB-44P *

*See the "Accessories" section for more information.